

# Sanitary partition wall type SVF30

Cubicle system made of 30 mm chipboard

**schäfer**<sup>®</sup>  
Trennwandsysteme



Stylish and elegant partitioning.



BEFORE WE  
EXPECT TRUST FROM  
OUR CUSTOMERS,  
WE PROVIDE EVIDENCE  
*that's us!*

## ENVIRONMENT & SUSTAINABILITY *that's us!*

Sustainable management and careful use of resources are a matter of course for us and part of our corporate philosophy. This basic idea is consistently integrated and lived in our work processes. We are proud to be the first certified manufacturer of partition systems and lockers in Germany to operate according to the FSC™ and PEFC guidelines.

### PEFC - registered

We pay attention to a sustainable supply chain in which our products are procured under ecological, economic and socially just aspects.

### FSC™ - certified

As the first certified manufacturer in the area of partition systems and lockers in Germany, we make an active contribution to the protection of our earth with this future-oriented procurement method. We supply almost our entire range from sustainable wood in accordance with the specifications of the FSC™.



On request  
the products are  
available with  
FSC™ certification

To certificate >

## TÜV NORD GS TESTED SAFETY *that's us!*

Tested and certified by TÜV NORD these products meet the requirements of the Product Safety Act ProdSG § 21  
Registration No. 44 329 14148802



## MADE IN GERMANY *that's us!*

Our products are manufactured for you at the company site in Horhausen, Rhineland-Palatinate. This is the only way we can guarantee the high quality standards we set for our products.



## PREQUALIFIED *that's us!*

We are registered in the list of prequalified construction companies with the number 010.049740, proving that we are qualified for the products and services we offer.



For listing >

## INNOVATIVE & DESIGN-ORIENTED *that's us!*

With our design-oriented and innovative products, we convince not only our customers, but also national and international committees.





## Flush fitted, minimalistic and extremely proven.

The Schäfer WC partition wall type SVF30 is an excellent choice if pure function and an attractive design is required. The flush-fitted cubicles, made of melamine resin-coated solid chipboard and coloured ABS strips, are characterised by smooth fronts. Quick cleaning, effective edge protection and an attractive design are convincing arguments for this type of partition.



#### Interesting facts about SVF30

##### WC partition walls made of 30 mm thick chipboard

- ABS strips in the same colour as the panels
- Flush fitted front on the outside of the cubicle
- Suitable for dry rooms
- Wall connections optionally available with shadow gap
- Easy to clean and maintenance construction
- Large variety of decors and colours
- System will be produced acc. to the building site dimension

##### Privacy screens

- Wall-mounted privacy screens
- Made of 30 mm thick chipboard
- ABS strips and panels in the same colour
- Installed with durable aluminium holders
- Wall-mounted structures without bottom support feet are particularly hygienic, since floor cleaning can then be faster and more efficient
- Wide range of colors available
- Motif prints are optionally available
- Privacy screens will be produced acc. to the building site dimension





## Features type SVF30

### Supports:



- Stainless steel supports, height-adjustable



- Aluminium supports, height-adjustable, price neutral

### Hinges:



- Stainless steel hinge with high-performance polymer
- Treads guarantee absolute freedom from maintenance and a silence closing of the door



- Stainless steel rising hinge
- Doors with self-closing hinges are optional available

## Variations of accessories type SVF30

### Hardware:



Aluminium  
door handle  
Schäfer AL7050



Stainless steel  
door handle  
Schäfer ES6050

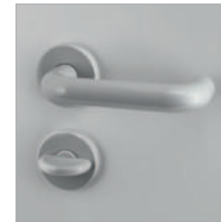

Nylon  
door handle  
Schäfer N8051



Aluminium  
one hand door knob  
INSAFE



Aluminium  
push handle SLIDESAFE

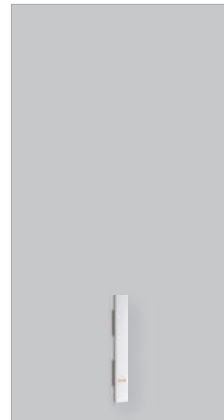

Aluminium handrail  
55 x 500 mm  
Schäfer ALGS1

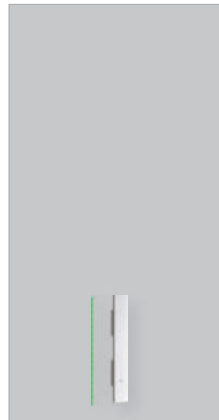

Aluminium handrail  
with LED strip  
55 x 500 mm  
Schäfer ALGS1 LED

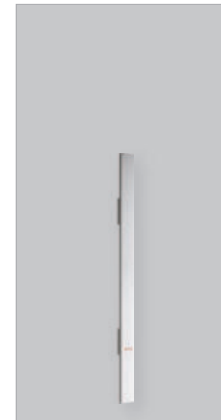

Aluminium handrail  
55 x 1.150 mm  
Schäfer ALGS2

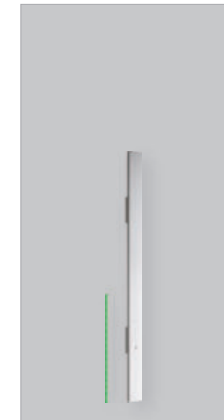

Aluminium handrail  
with LED strip  
55 x 1.150 mm  
Schäfer ALGS2 LED

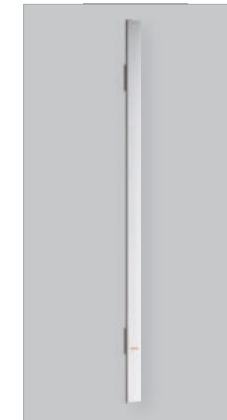

Aluminium handrail,  
adapted to the door  
length, always until the  
top edge of the door  
Schäfer ALGSV



Aluminium handrail with  
LED strip, adapted to the  
door length, always until  
the top edge of the door  
Schäfer ALGSV LED

[To the handrail configuration online tool >](#)

[To the push handle SLIDESAFE >](#)

[To the sanitary accessories >](#)

### Buffer and hooks:



Aluminium buffer  
Schäfer AL7015



Stainless steel buffer  
Schäfer ES6015

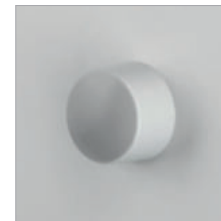

Nylon buffer  
Schäfer N8015



Aluminium hook  
Schäfer AL7011



Stainless steel hook  
Schäfer ES6011



Nylon hook  
Schäfer N8010

## Colours type SVF30

### Panels:



1001  
Weiß

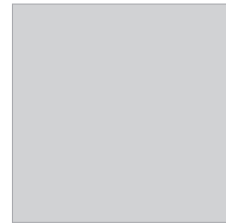

1002  
Silbergrau



1004  
Anthrazit



4001  
Aluminiumgrau  
Metallic



2003  
Arktis



2005  
Rot



2006  
Limonengrün

### ABS strips:



1001  
Weiß

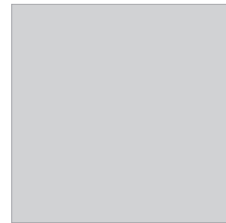

1002  
Silbergrau



1004  
Anthrazit



4001  
Aluminiumgrau  
Metallic



2001  
Goldgelb

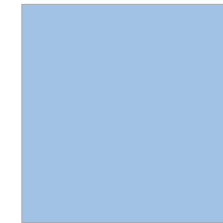

2003  
Arktis



2005  
Rot



2006  
Limonengrün



2007  
Ultramarinblau

Special colours for panels, ABS strips and profiles in all RAL colours and special accessories are available upon request. Ask us!

There may be a difference between printed colours and real colours.

### Profiles:

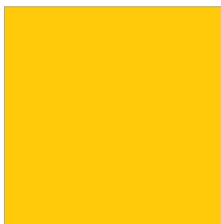

RAL 1023  
Verkehrsgelb



RAL 3003  
Rubinrot



RAL 5002  
Ultramarinblau



RAL 7038  
Achatgrau

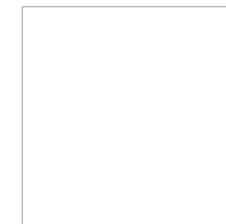

RAL 9010  
Reinweiß

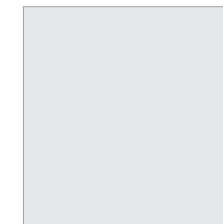

E6/EV1  
Eloxiert



## Technical design of cubicle system type SVF30

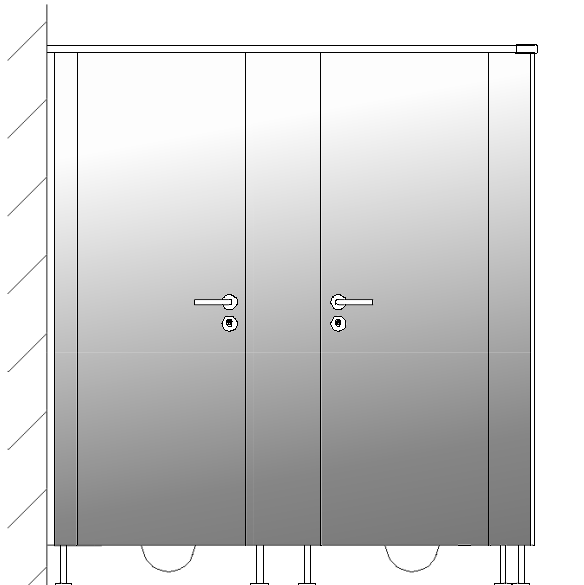
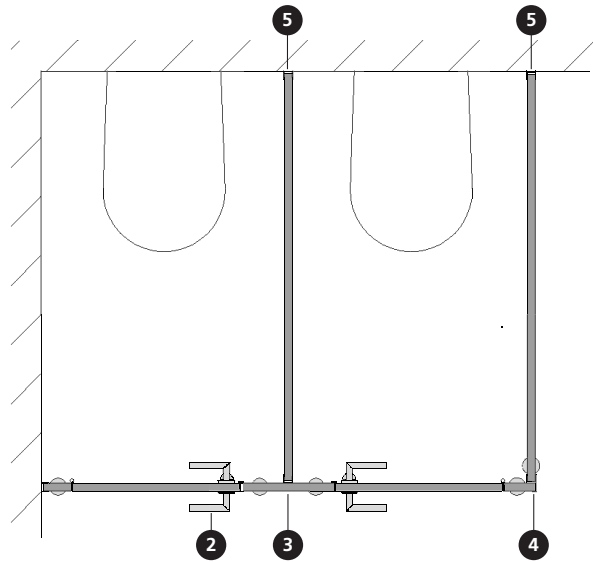

- 2** Cubicle front section with door handle.  
Wall connection with an U-profile as shadow gap (optional)

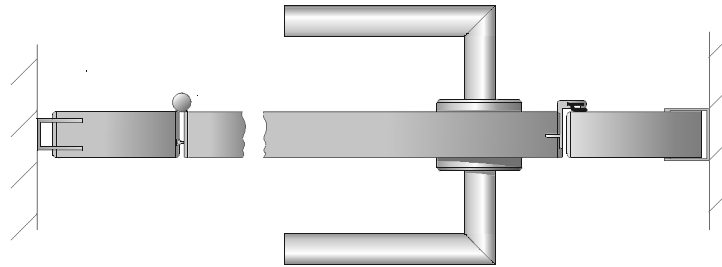

- 1** Front height section

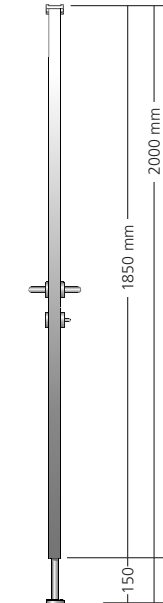

- 4** Corner attachment

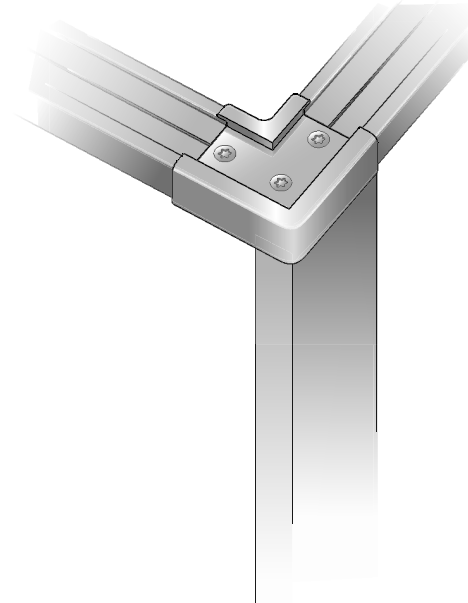

- 3** Front to partition wall connection

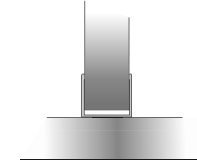

- 5** Wall connection with encompassing U-profile

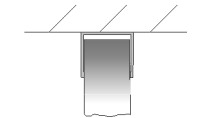

- 5** Wall connection with an U-profile as shadow gap optional

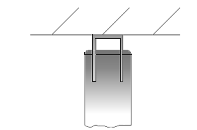

We reserve the right to make technical alterations.



reddot winner 2021

